

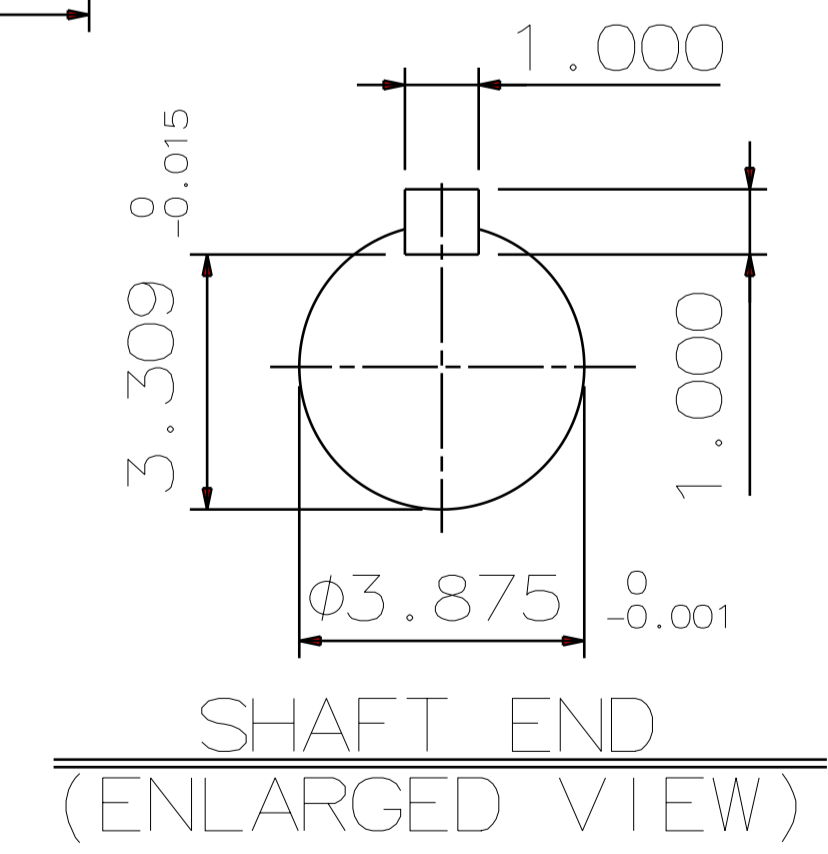

DETAIL A
(PROVISION FOR VIBRATION SENSOR)

TYPE	OUTPUT		POLE	TIME RATING	VOLTAGE V	Hz	SYN. SPEED R.P.M
	HP.	kW.					
AEHAGD	500	372.8	4	CONT.	2300/4000	60	1800

TOTALLY ENCLOSED FAN-COOLED TYPE, SQUIRREL-CAGE ROTOR

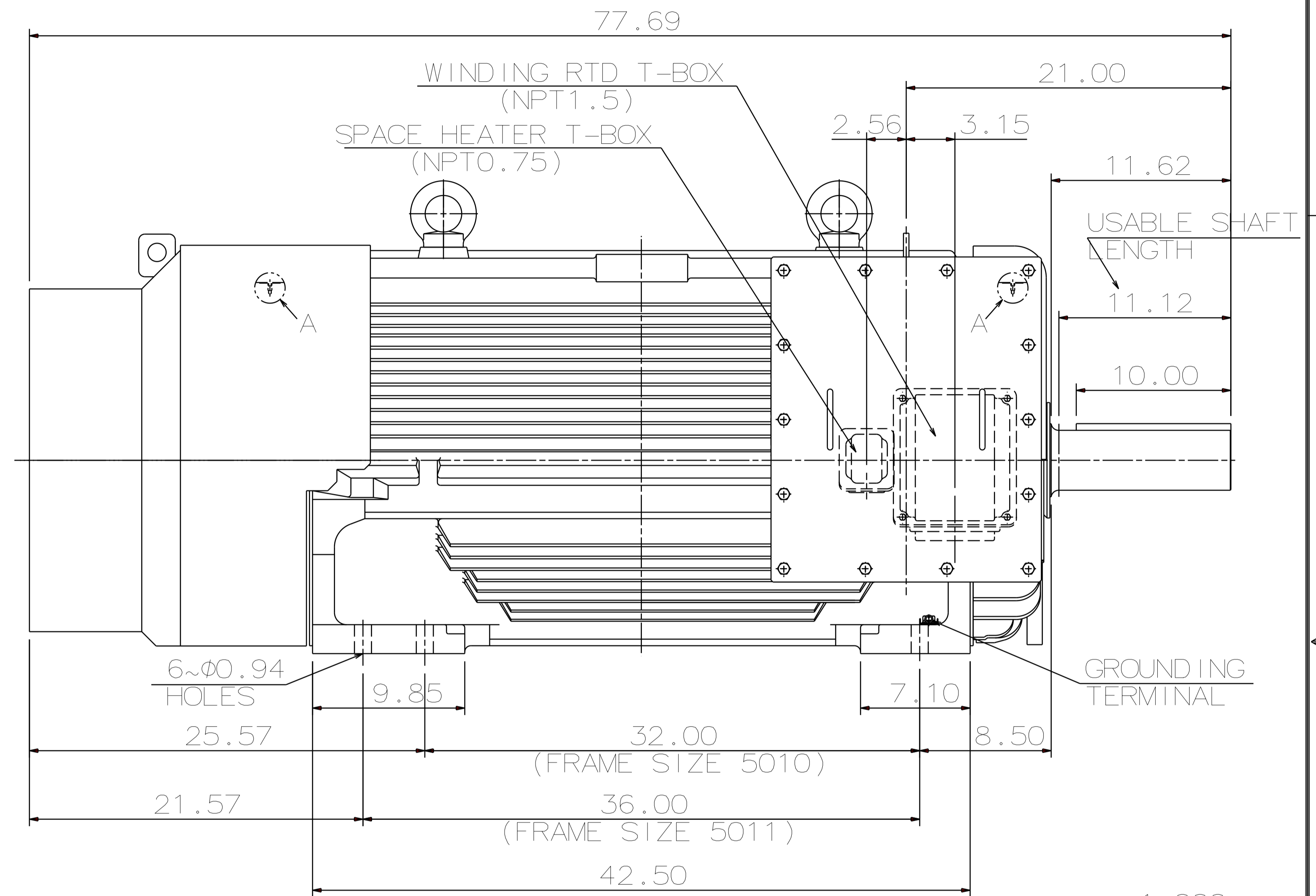
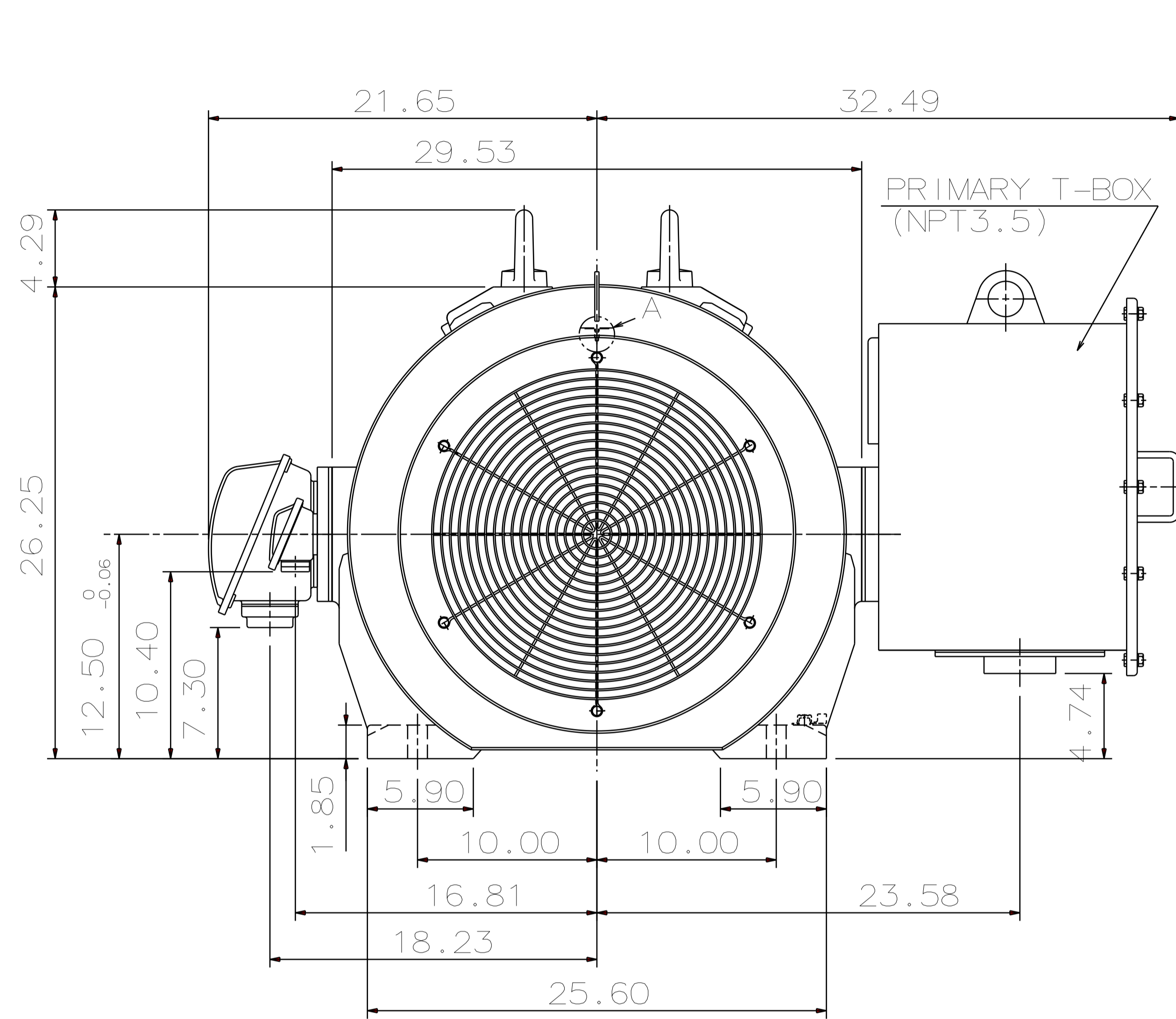

- NOTE:
1. DIMENSIONS IN inch
 2. FRAME NO. 5011B
 3. F CLASS INSULATION, S.F.1.15
 4. FOR DIRECT FLEXIBLE COUPLING
 5. ENCLOSURE: IP55
 6. BEARING SIZE: DRIVE-END 6324
OPP. DRIVE-END 6320
 7. WITH WINDING RTD: PT 100Ω/0°C 6PCS
 8. WITH SPACE HEATER: SINGLE PHASE, 120V
 9. PROVISION FOR BEARING RTD MOUNTING: 2~PT1/2" TAPS PER BRACKET
 10. NON-SPARKING FAN
 11. CORROSION PROOF
 12. APPROXIMATE WEIGHT: 4,845 LBS

DATE	DEC 08 2016	OUTLINE DIMENSIONS	
	KD5004	3-PHASE INDUCTION MOTOR	
DWN.	J. CHANG	MAY. 26. 2015	
CHKD.	H. HUANG	MAY. 26. 2015	
APPD.	C. LIU	MAY. 26. 2015	
TEC Westinghouse		DWG NO.	REV: 00
		4B040L391	